



uSpectrum PC Software

Download File

www.uprtek.com → Membership → Login → Support → Download Center



uFlicker PC Software

Download File

www.uprtek.com → Membership → Login → Support → Download Center



Original / Authorized Agent Stamp

*To ensure your warranty valid effect, please place your age of 100 days in the box and fill in the purchase date. If the age of 100 days of purchase date cannot be supplied, the warranty period will be reduced to the manufacturing date of the product.

Product Serial Number : _____

Purchase Date : _____

32-72-000-01-00-00

UPRtek United Power Research Technology Corporation

Tel : +886-2752-9443

Fax : 886-2752-9444

Fax : +86-027-888-390

Address: 160-35, 5th fl. of 32, Zhongxing Rd., Muzha Dist., Taipei City 115, Taiwan, R.O.C.



MK350N Premium Spectrometer

User Manual



1	Introduction	04
	1.1 Packing Contents	05
	1.2 Appearance Introduction	06
	1.3 Annual Product Calibration	07
	1.4 Product Notes and Precautions	07
2	Preparations before Use	08
	2.1 Preparing Before Use	09
	2.2 Basic Measurement	13
	2.3 System Reset	14
3	System Overview	18
	3.1 Main Page	19
	3.2 Measurement Modes Introduction.....	21
	3.3 Measurement Introduction.....	22
	3.4 Measurement Setting Introduction.....	23
	3.5 Continuous Measurement Introduction	26
	3.6 Customizing BASIC Mode List	27
	3.7 Instruction of Spectrum Mode	28
	3.8 Switch Between CIE1931 & CIE 1976	29
	3.9 TM-30 Mode Introduction	30
	3.10 BROWSER Mode Introduction	31
	3.11 FLICKER Mode Introduction.....	32
	3.12 FREQUENCY Mode Introduction	34
	3.13 Compare Mode Introduction	35
	3.14 Transferring Data with P.C Connection	36
	3.15 Connecting with Mobile APP	37
	3.16 Connecting with uSpectrum	38
	3.17 Connecting with uFlicker	39

4	Specification	40
	4.1 Product Specification	41
	4.2 Product Appearance and Dimension	43
5	Appendices	46
	5.1 Product Warranty Terms	47
	5.2 Measurement	50
	5.3 Q&A	59



To get more information related to operation, firmware upgrade and warranty terms; or file application for correction and repair service, please visit www.uprotek.com to download the corresponding website.

1

Introduction

- 1.1 Packing Contents
- 1.2 Appearance Introduction
- 1.3 Annual Product Calibration
- 1.4 Product Notes and Precautions



1.1 Packing Contents

Please check MK350N Premium packing before use, contact your agent if there are missing items.



MK350N Premium Spectrometer



Protection Bag



Battery



Case



Screen wiper



Strap



Neck Strap



Stand Bracket



SD card



USB Cable
(It is used to connect with PC software.)



Power Adapter



User manual



Warranty card



WiFi Wing
wireless remote control card
(It is used to connect with Wi-Fi.)

1.2 Appearance Introduction

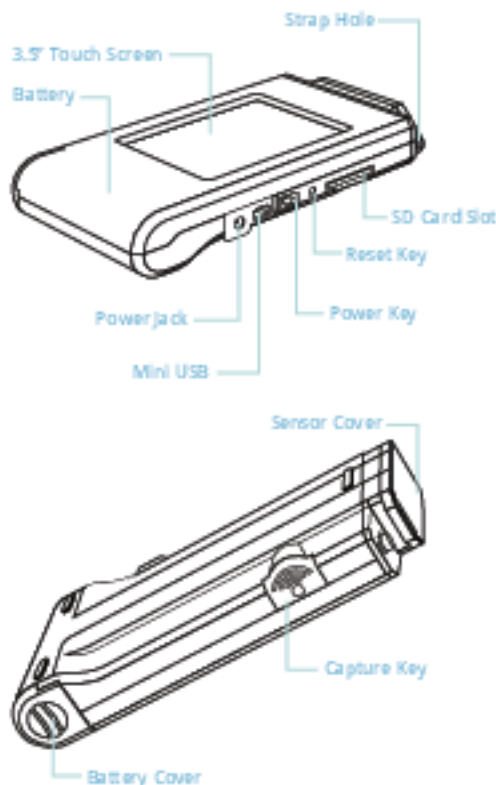

If the system crashes, please press the power key for 3 seconds to turn off the system.

If the problem still can't be fixed, please use a pin to press the reset key to turn off the system.



1.3 Annual Product Calibration

As the product is a high-precision instrument, please use it cautiously. To ensure the accuracy of measurements, annual calibration is recommended. Please consult the agent or the customer service department for the calibration service.



1.4 Product Notes and Precautions

1. MGS50N Premium Spectrometer is a high-precision instrument. Please unpack with care. Any vibration or collision may cause instrument damage. If the product doesn't work normally or needs repair, please don't attempt any repairs. All repairs must be performed by the authorized customer service agent.
2. Most LCD screens have a very small and inconsequential defective pixel rate (usually less than 0.1%). This results in occasional pinpoints of white or other colors but will not affect the accuracy of measurements.



Precautions / Warnings

Please read the following precautions to avoid fire, excessive heat, chemical leakage and explosion:

- Do not disassemble or modify the battery.
- Do not expose the battery to heat (fire) or water/moisture.
- When disposing used/old batteries, wrap with insulation tape to shield the battery from electrical contact with metallic objects, which might ignite a fire or explosion.
- If the unit is plugged into the power adapter and the battery seems to be overheating, or if there is smoke or peculiar odors emanating from the unit, unplug immediately to avoid the possibility of fire.
- However, do not touch the cables if there is heat emanating from near the cables as melted or deformed cables could expose wiring and result in burns or electric shock.
- Do not use cloth or anything to wrap or cover the equipment while charging – this could cause the unit to overheat, melting the casing or causing fire.
- If the unit is accidentally immersed in water, or if moisture has seeped inside, or metal objects have dropped into the casing, immediately remove the battery to avoid fire or electric shock.
- Do not operate or store the battery in high-temperature environments—it will cause battery leakage and/or shorten the life of the battery.
- Do not use paint thinner, benzene or other organic solvents to clean the equipment – this may damage the exterior finish or touch screen, and may even ignite fire.

2

Preparations before Use

- 2.1 Preparing Before Use
- 2.2 Basic Measurement
- 2.3 System Reset



2.1 Preparing Before Use

Battery installation :

Step1. Hold MK350N Premium, then press the battery cover.

Step2. Press the battery cover down to remove it.

Step3. Install the battery after removing battery cover.



※ Press the battery cover down then you can remove the cover smoothly from MK350N Premium.

1. Please charge the battery for 6 hours at first time usage.
2. To avoid any interruption while measuring, please check battery status before use.
3. Please purchase a new battery if it gets low easily after being fully charged, which means battery life comes to an end.
4. Usage time will depend on battery life, MK350N Premium battery can operate 5 hours after being fully charged.



2.1 Preparing Before Use

Battery charging :

1. Plug power charging cable into power jack to start charging.

2. Power Off Status: Users can check power key, it will light in red while charging and light off after being fully charged.

3. Power On Status: Users can check MK350N Premium screen, it will appear a lightning symbol to indicate charging, and lightning symbol will disappear after being fully charged.

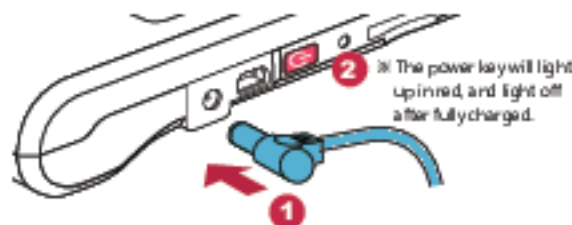

※ The power key will light up in red, and light off after fully charged.

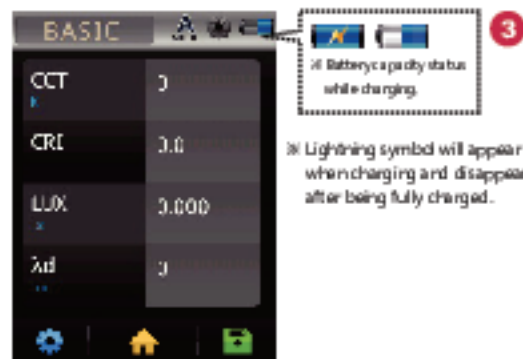

※ Battery's a party status while charging.

※ Lightning symbol will appear when charging and disappear after being fully charged.



2.1 Preparing Before Use

Installing the SD Card :

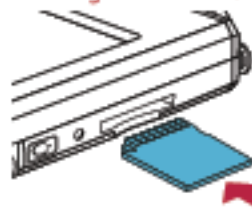

※ Insert the memory card according to the direction.

Remove the SD Card :

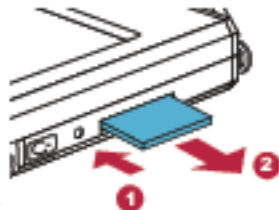

※ Press to remove the SD card

Strap installation :

Step1. Unscrew the strap.

Step2. Tie the strap to the strap hole of MK350N Premium.

Step3. Tie the strap to the sensor cover.

Step4. Screw the strap.

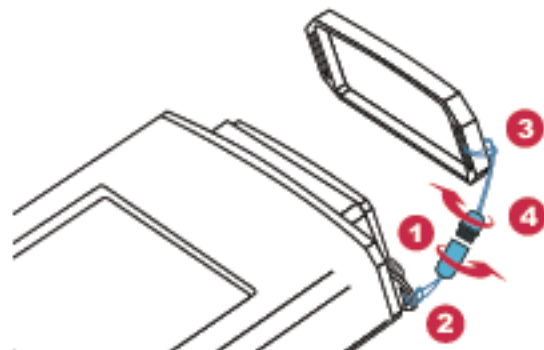

2.1 Preparing Before Use

Power on

Press the Power button for 1 second and then release it.



※ When the power is on, the Power button will turn on the green indicator. When the power is off, the green indicator will be off.

Dark calibration

When the system is powered on and the powerkey is in green, the screen will show the Dark Calibration.



"Do you want to do dark calibration?" Please select "Yes".



After the sensor cover is pushed, please select "OK".



When the screen shows "Dark calibration completed", please press "OK" to enter the main page.



It is recommended performing dark calibration every time when it is powered on.



2.1 Preparing Before Use

Set date and time

After the dark calibration is completed, please set date and time before measurement.



1 Go to the next page.

2 Select "Option".

3 Select "Date" and "Time".



4 After the setting is finished, please press "Yes".

5 After the setting is finished, please press "Yes".



Please press the power key for 3 seconds to turn off the system.



2.2 Basic Measurement

Measure

Select "Basic" to enter measurement page.

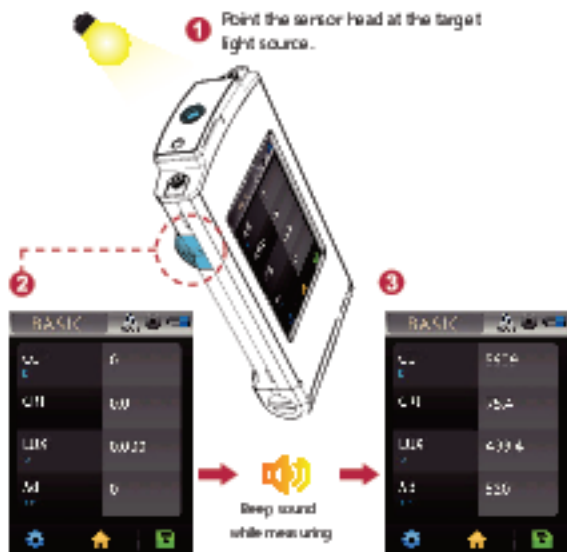

Press Capture key at appropriate distance.

The measurement data will be shown on the screen after beep sound.



2.2 Basic Measurement

Save measurement data



Press Savekey on the lower right of the screen, and select 'Yes' key.



The measurement data are saved in the memory card successfully. Please record the file name if necessary.

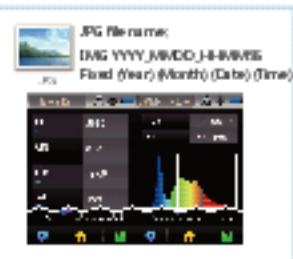
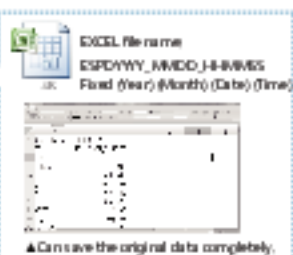

2.3 System Reset

Users can press the reset key to turn off the system if system crashes.

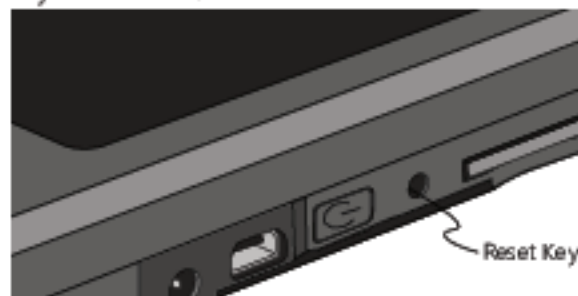

3

System Overview

- 3.1 Main Page
- 3.2 Measurement Modes Introduction
- 3.3 Measurement Introduction
- 3.4 Measurement Setting Introduction
- 3.5 Continuous Measurement Introduction
- 3.6 Customizing BASIC Mode List
- 3.7 Instruction of Spectrum Mode
- 3.8 Switch Between CIE1931 & CIE1976
- 3.9 TM-30 Mode Introduction
- 3.10 BROWSER Mode Introduction
- 3.11 FLICKER Mode Introduction
- 3.12 FREQUENCY Mode Introduction
- 3.13 Compare Mode Introduction
- 3.14 Transferring Data with PC Connection
- 3.15 Connecting with Mobile APP
- 3.16 Connecting with uSpectrum
- 3.17 Connecting with uFlicker



3.1 Main Page

The interface of the product is touch screen operation. By touching the screen with your figure, you may select the target menu or option.

The sub menus of each measurement mode are as shown below.

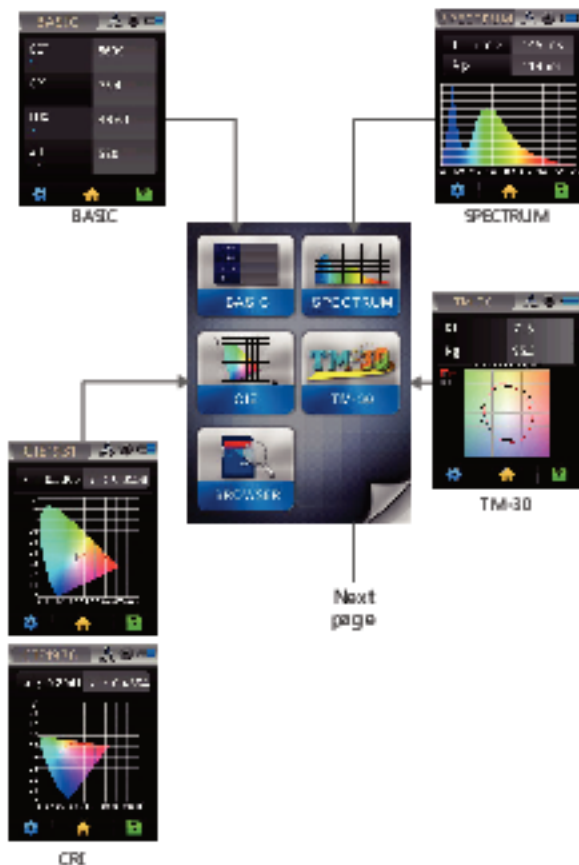

3.1 Main Page

The interface of the product is touch screen operation. By touching the screen with your figure, you may select the target menu or option.

The sub menus of each measurement mode are as shown below.

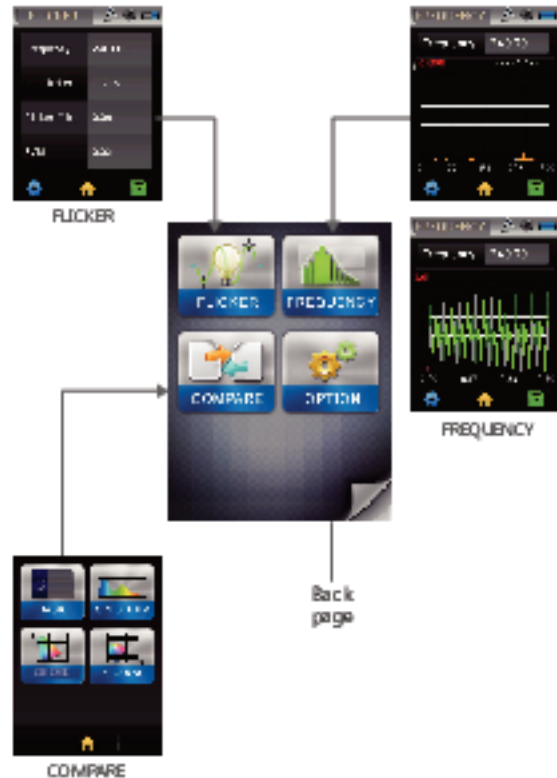



3.2 Measurement Modes Introduction

Interface introduction :

 Means button



1. Measuring Mode - Basic
2. Exposure Mode - Automatic mode / Manual mode
3. Measuring Function - Single operation / continuous operation. For continuous measurement, please refer to 3.5.
4. Battery Power
5. Measurement Setting - please refer to 3.4.
6. Back to Main Page
7. Store the measured data - please refer to 3.3.
8. Show measured data - It shows different data based on the measuring mode. You may make selections by yourself.



3.3 Measurement Introduction

Save measured data :

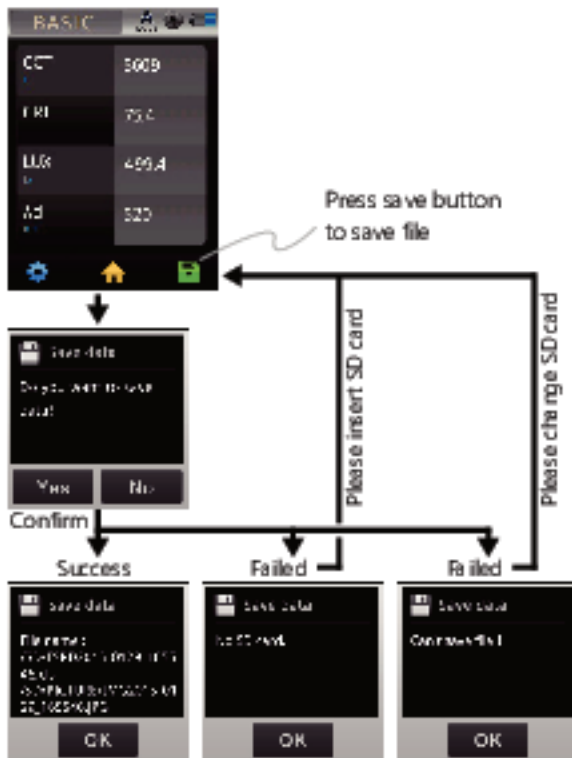



3.4 Measurement Setting Introduction

Please go to measurement page to do measurement settings.



Measurement page

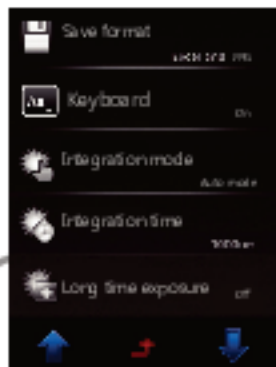

Previous page

Back to measurement page

Next page

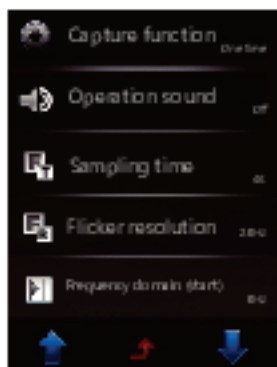

3.4 Measurement Setting Introduction

Save Format Setting :



Integration Mode Setting :



Integration Time Setting :



Long time exposure Setting :

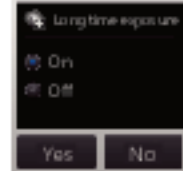

Capture Function Setting :



Operation Sound Setting :



Sampling time Setting :



Flicker resolution Setting :



+ / - : Adjust by
Yes / No : End of the setting



3.4 Measurement Setting Introduction

Frequency domain(start) :



Frequency domain(end) :



Dark calibration Setting :

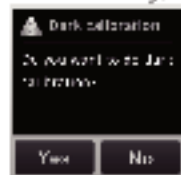

Keyboard Setting :



Keyboard ON: The keypad interface will show up when saving file, which allows you to rename the file.
Keyboard OFF: It will skip the keypad interface when saving files, and rename the file automatically.

Keyboard Instruction :



Key in the number or English letter.

Select it to show the input value on the upper side.

Delete the input English letter or number.

Confirm the input value and save it, then return to the interface.



3.5 Continuous Measurement Introduction

1



Select Continuous

2



3

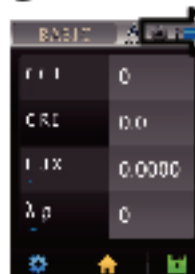

If the capture symbol is rotating when NIGSON Premium will process continuous measurement.

4



Basic mode
(starts measurement)
press capture key

NIGSON Premium will process
measurement with
interval of 2 seconds.

Basic mode
(after measurement)
Press the capture key again to
see the measurement results.

Step1. Select the continuous capture

Step2. Press the capture key

Step3. Processing the continuous measurement

Step4. Press capture key again to stop continuous measurement



1. Continuous measurement has no beep to sound after press capture key.
2. Users cannot save the measurement data while processing continuous measurement.
3. Adjust the integration time is only allowed in the manual mode.



3.6 Customizing BASIC Mode List

The 4 items on the Basic list can be customized with different units of measure (e.g. CQ5, fc, R9, TLQ).

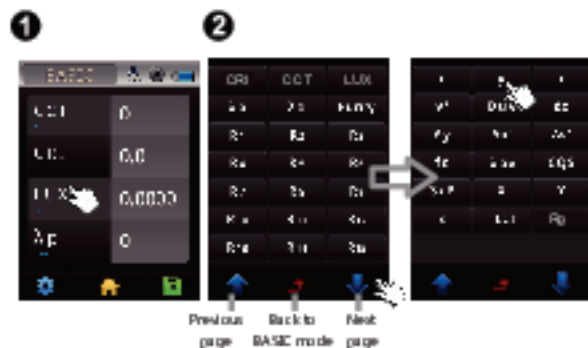

For more information about Measurement Index, please refer to 5.2.



3.7 Instruction of Spectrum Mode

Interface introduction :

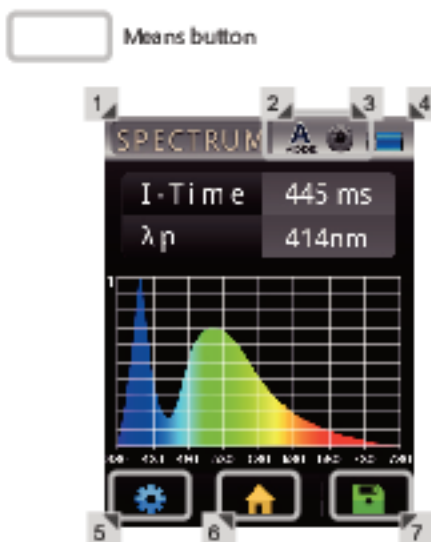

1. Measuring Mode - SPECTRUM
2. Exposure Mode - Automatic /Manual M
3. Measuring Function - Single operation /continuous operation . For continuous measurement, please refer to 3.5.
4. Battery Power
5. Measurement Setting - please refer to 3.4.
6. Back to Main Page
7. Store the measured data - please refer to 3.3.



3.8 Switch Between CIE1931 & CIE1976

Touch the graph to switch the table between CIE1931 and CIE1976.

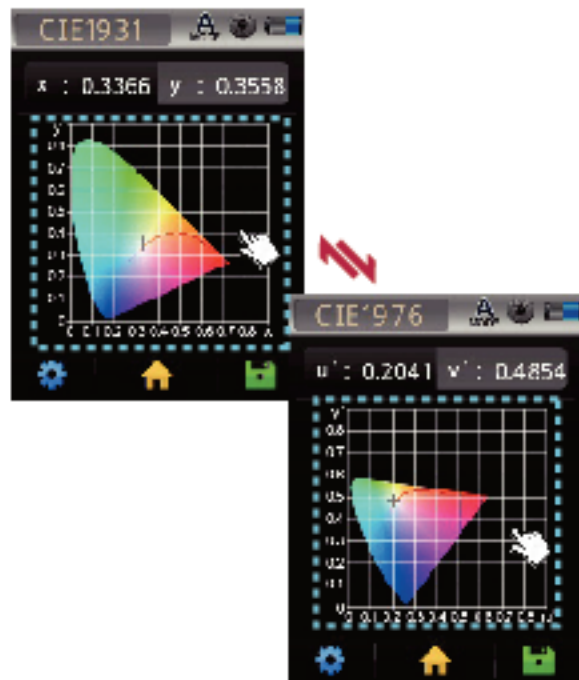

3.9 TM-30 Mode Introduction

TM-30-15 provides equations and direction for calculating Fidelity Index (Rf) and gamut (increase or decrease in chroma) through a Gamut Index (Rg), including the spectral reflectance functions for 99 Color Evaluation Samples (CES).

Rf : Fidelity Index

Rf takes a maximum value of 100. If Rf is 100, it is a match to the reference source (true to the "real color", similar to CRI Ra 100). If color shifts occur, the arrows get longer and Rf decreases (to a minimum value of zero).

Rg : Gamut Index

Rg=100 means that the test light source does not change the hue or saturation of the CES compared to the reference source.

Rg>100 indicates that the test light source increases the saturation of the CES producing colors that are more vivid.

Rg<100 indicates that the test light source decreases the saturation of the CES producing colors that are less saturated.

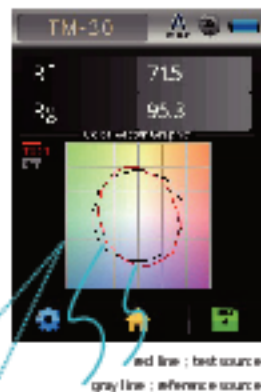

Color Vector Graphic : one of the outputs of TM-30.

This graph can tell us how, on average, various colors are distorted.

1. outward arrows mean more saturated colors
2. inward arrows mean duller colors
3. sideways arrows means a hue shift
4. no arrow means that the color isn't distorted



3.10 BROWSER Mode Introduction

The Browser (on Home Screen) allows you to review historical data that was previously saved to the SD card.

1



2



3



Back to list

4

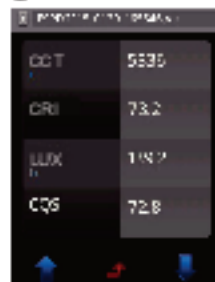

Step1. Press the "BROWSER" icon

Step2. A file browser will show the files on the SD card.
If you select an excel file, a review menu will be displayed.

Step3. Press any of the icons to review the data.

Step4. Displaying the data of excel file.



3.11 FLICKER Mode Introduction

Interface introduction :



Means button



1. Measuring Mode - FLICKER

2. Exposure Mode - Automatic / Manual

3. Measuring Function - Single operation / continuous operation . For continuous measurement, please refer to 3.5.

4. Battery Power

5. Measurement Setting - please refer to 3.4.

6. Back to Main Page

7. Store the measured data - please refer to 3.3.



Interface introduction :

 Means button

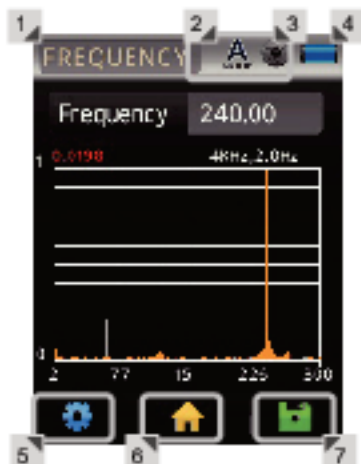

1. Measuring Mode - FREQUENCY
2. Exposure Mode -Automatic  /Manual 
3. Measuring Function -Single operation  /continuous operation  .For continuous measurement, please refer to 3.5.
4. Battery Power
5. Measurement Setting - please refer to 3.4.
6. Back to Main Page
7. Store the measured data- please refer to 3.3.



Touch the graph to switch the table between Frequency.

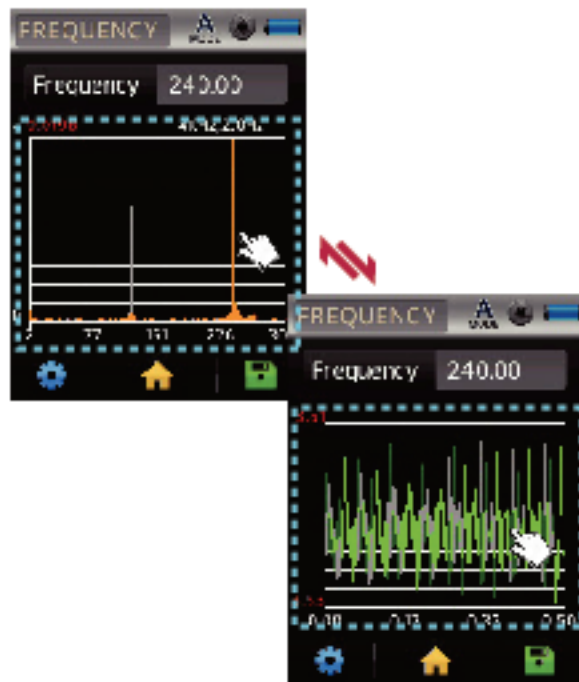

More about FFT: Refer to Page 27 - Page 40 of Flicker Handbook.
More about Light Wave: Refer to Page 25 - Page 26 of Flicker Handbook.



3.13 Compare Mode Introduction

Users can use the real-time measurement or select the historical measurement data to show the measured light source data with parallel display. We offer four modes that allow you to compare the measurement of the source data: BASIC, SPECTRUM, CIE 1931 and CIE 1976.

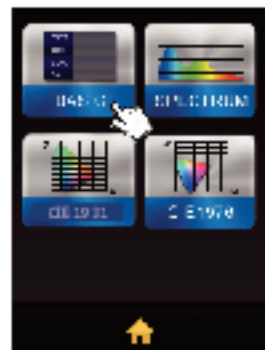

Select the "light source" mode you need.



After the measurement is completed, the measured light source data are compared by parallel display.



3.14 Transferring Data with PC Connection

Storage the measurement data :

Inside the package has a USB cable, connect the mini USB to MK350N Premium and plug the USB to your PC then you can read the data saved in SD card.



After connected USB cable, MK350N Premium will display as below.



3.15 Connecting with Mobile APP

WiFi Wing wireless remote control card

Insert WiFi Wing card to the system. At iOS or Android platform download MK350N Premium APP and install it on your mobile. Then you can connect it with system for the measurement of wireless control.

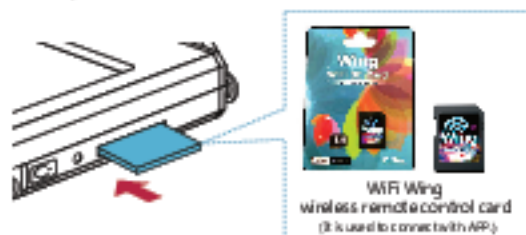

For more operation, please refer to Wing user manual. Please visit UPRtek official site, <http://www.uprtek.com> → Support → Download Center.

Install APP

Download and install the MK350N Premium APP on your Mobile.



2 Select WiFi UPRtek_Wing.



Measure



3.16 Connecting with uSpectrum

Install uSpectrum PC software

Please visit UPRtek official site, <http://www.uprtek.com> → Support → Download Center, Download and install uSpectrum software on the PC. Then you can connect it with the system for USB control of measurement.

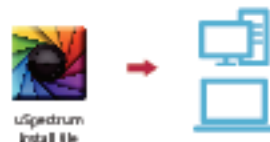

Set USB PC connection mode



Measure





3.17 Connecting with uFlicker

Install uFlicker PC software

Please visit UPRtek's official site, <http://www.uprtek.com/Support/Download Center>, Download and install uFlicker software on the PC. Then you can connect it with the system for USB control of measurement.



Set USB PC connection mode



Measure



4

Specification

4.1 Product Specification

4.2 Product Appearance and Dimension



4.1 Product Specification

Emission		
Screen	0 MHz linear range 0 area	
Powerline Range	300 to 700 mV	
Powerline Data Movement	1 cm	
Spectral Bandwidth	0 periodically 10 mV (full E meter BW)	
Powerline Reproducibility	< 1 cm (avg) concerned for unshielded screen	
Measurement Range	E to 100,000 Hz	
Bandwidth Accuracy	±0.2%	
Bandwidth Reproducibility (%)	±0% (100 - 100,000 Hz) ±0% (E - 100 Hz)	
Gain Accuracy	Bandwidth 0 @ 0.001 Hz at 20,000 Hz / Temperature 20°C and relative humidity 50% or less	avg ± 0.002 (E to 1000 Hz) ±0.0005 (at 0.001 Hz)
Gain Reproducibility	avg ± 0.000 (100 to 100,000 Hz) avg ± 0.000 (E to 100 Hz)	
Gain Reproducibility (%)	±0%	
EMF Accuracy	±0%	
EMF Accuracy @ 1 Hz	±0.2%	
Ray Light	EMF all area (avg) the EMF screen is made light underneath the ray light without EMF screen (less)	
Integrator Time Range	100ms to 1,000 ms	
Digital Resolution	10 bits	
Filter		
Measurement Range	E to 100,000 Hz	
Sampling Rate	100k samples/sec	
Passport Range	E to 100 Hz	
Passport Resolution	2, 4, 8, 16, 32 Hz	
Filter Accuracy	±0%	
Feature		
Capture Function	One Wire / Continuous	
Operator Mode	0 Antenna/Mode / (PST) Mode (E can be connected to enable phone antenna) / USB Mode (4000 Mode (4000 - Max Storage than 1 = PC connection)	
Integrator Mode	0 Off/Normal 1. Band Mode 2. Spectrum Mode 3. EMF Mode 4. EMF 1001 / 102% Green/Red Mode	
Measuring Mode	E, 70, 100, 10 MHz E, Filter Mode 7. Frequency Mode 8. Screen Mode 9. Capture Mode	



4.1 Product Specification

Measurement Range	1. Bandwidth (kHz) / Peak/width (Hz) 2. Green/Red Color Temperature (K, Hz) 3. EMF 1001/102% Green/Red (1) EMF 1001 ± 0.1 Green/Red (2) EMF 1001 ± 0.1 Green/Red (3) EMF 1001 ± 0.1 Hz 4. mV, μV, mV, μV 5. Data to (Hz) 6. Green/Red Powerline (Hz) 7. Resolution only 8. Color Temperature/EMF (Hz, Hz) / Hz to Hz 9. Color Quality (Hz) (Hz) 10. Television Lighting Green/Red/Blue (Hz, Hz) 11. 70, 100, 10 Hz, Hz, Hz, Hz, Hz, Hz 12. Filter Accuracy 13. Power Filter 14. Filter Filter 15. Green/Red/Blue / 1000/1000/1000 (Hz) 16. Spectral Power Line Filter (Hz) (Hz) 17. Peak/W average (Hz) 18. Peak/W average (Hz) (Hz) 19. Integrator Time (Hz, Hz) 20. Sample and P Integ/Filter (Hz)
Display & Information	
Display	3.5" 1000x2000/1000x1000
Max. File	~ 10,000 File @ 100 Hz / 100 Hz / 100 Hz
File & Operator Time	± 0.1 sec. / 0.1 sec. / 0.1 sec.
Power	Adaptor 2000 mAh (3.7V) / 1000mAh/1000mAh Battery
Color Output Interface	100 Hz (100 Hz) / 100 Hz (100 Hz) 100 Hz (100 Hz) / 100 Hz (100 Hz)
Color Power	100 Hz (100 Hz) / 100 Hz (100 Hz)
Extension	100 Hz (100 Hz) / 100 Hz (100 Hz)
100 Hz (100 Hz) Battery	100 Hz (100 Hz) / 100 Hz (100 Hz)
Operating Temperature	±0.1% (E - 100 Hz)
Frequency	relative humidity 70% or less or 1000 Hz constant
Frequency Temperature	±0.1% (E - 100 Hz)
Frequency	relative humidity 70% or less or 1000 Hz constant
Display Language	English / Traditional Chinese / Simplified Chinese / Japanese / Spanish / German / French / Italian / Russian
Color & Resolution	

The company reserves the right to change product specifications at any time without prior notice.



4.2 Product Appearance and Dimension

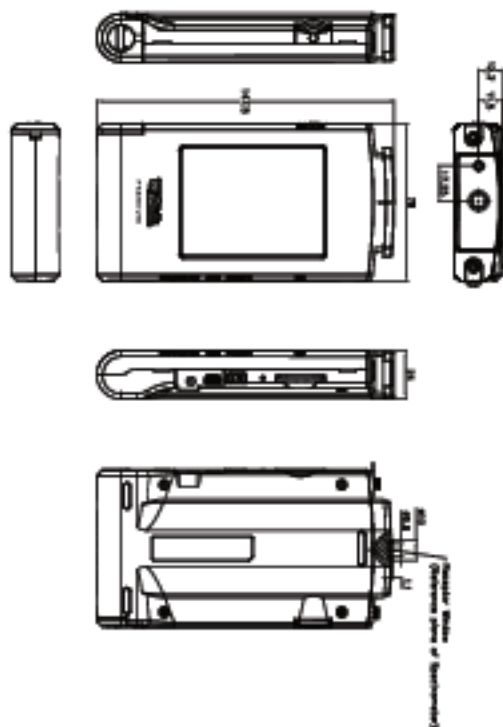

Unit: mm



4.2 Product Appearance and Dimension

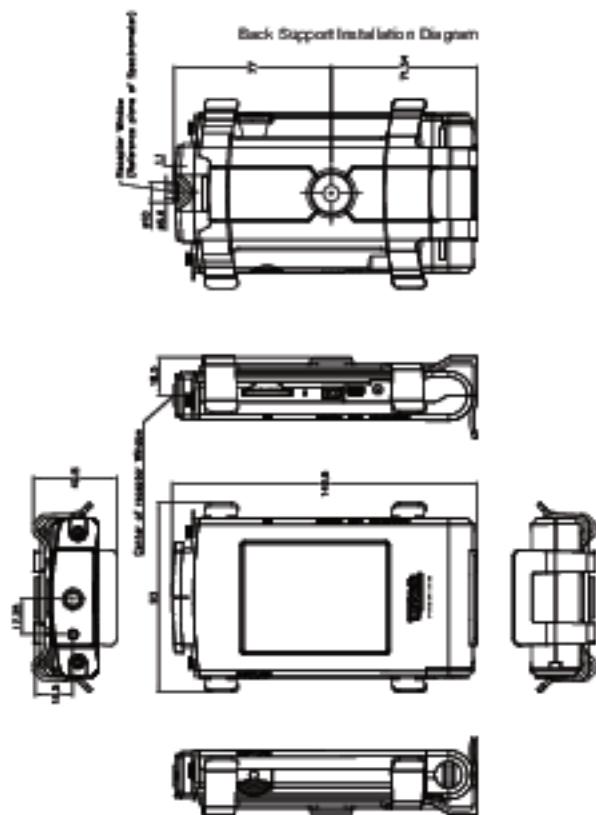

Unit: mm

Appendices

5

5.1 Product Warranty Terms

5.2 Measurement Indexes

5.3 Q&A



Warranty Principles

UPRTEK provides the service of repairing or changing equivalent products for the customer in case of the material or functional defect and fault during the product warranty period.

1.Changing new product:

- If the consumer finds any functional defect or fault or finds any part missing within 7 days after purchasing the product, it should consult the original seller and report to the vendor immediately. Moreover, it should leave the contact information, so the customer service personnel of the original vendor will check it out and generate the number of changing new product for the customer. In this case, the original vendor provides the service of "changing new product" within 7 days.
- The customer should return the product to the original vendor within 30 days after getting the repair number. As for the international customer, it permits the flexibility of logistical time and expands the time for returning the product to the original vendor.

Remarks: It requires complete package when returning the product to the original vendor. There should be no part missing or scratch on the surface unless the part is found missing when the product is delivered. Under this circumstance, the original vendor reserves the ultimate right to determine whether to change new product.

2. Repair service:

- If it exceeds the period for changing new product (seven days), the functional non-compliance or defect found on the product should go through RMA workflow. When a product needs to be returned to the original vendor for repair, it should consult the business service personnel via Email, fax or phone call to apply for repair number before returning the product to the original vendor for repair service.



- After the original vendor receives the returned product, the internal engineer of the Company will check it initially and confirms the causes for product defect. If it is within the warranty period and it is the functional fault of the product, it should follow the general repair workflow. However, if the engineer checks it is human damage rather than functional fault, it is inapplicable to the warranty term.

Remarks: To avoid damage during the product transportation, we strongly recommend choosing international express service and protecting the product carefully.

Limited Warranty

The warranty term is inapplicable to the damage caused by unnatural or external factors, such as the following circumstances:

1. When the fault is caused by the natural disaster and improper human operation rather than the product itself;
2. When the product is repaired or disassembled by others rather than the technician authorized by the company;
3. When the warranty volume label or disassembly-pit of volume label is modified, damaged or gone;
4. When the product serial number is wrong, damaged or unclear.

Exemption from Liabilities

- UPRTEK is not liable to the product defect or damage caused by any factor during the transportation of sending MK350N Premium series product for repair. It is recommended taking out the storage device, packing and transporting the product properly on your own before sending the product for repair.
- UPRTEK is not liable to the compensation for the operation loss, expected cost loss, data loss caused by or related to the usage of the product of the Company, as well as any other indirect, accident or derivative loss or damage provided it is permitted by the laws.



Applicable Subjects for Warranty Terms

UPRTEK's warranty service terms are only applicable to the consumers who purchase the company products through formal or legal sales channels.

Warranty Period

1. Host of MK350N Premium series product:

UPRTEK provides two years of warranty service for all MK350N Premium series products, with free calibration service for one time.

2. Product supplies and related accessories:

The products supplies and the related accessories such as battery, tripod and neck strap, are excluded from the warranty service.

Services Provided by Authorized Agent or Distributor

- The qualified agent or distributor may receive or deliver the host of MK350N Premium series product for basic inspection, so as to confirm whether the device needs to be returned to the original vendor for further calibration service.
- URL of qualified agents or distributors: www.uprtek.com.
- The basic inspection service provided for the consumer is charged based on the announcement made by UPRTEK.

Other Notes

UPRTEK doesn't produce or manufacture all materials and parts of the product. If the target material and part is discontinued within the warranty period, UPRTEK is entitled to replace it with equivalent alternative to finish repair.

Sending for Repair

Consumer may send the product back to the original vendor RMA repair service through either of the following two methods:

- The consumer sends the product to UPRTEK's agent or distributor which will return it to the original vendor for repair.
- The consumer sends the product to UPRTEK for repair directly.



Service after Warranty Period

If any damage or fault occurs to MK350N Premium series product after two years of warranty period, the consumer may still return the product to UPRTEK for repair. However, the repair service should be charged based on the product fault or damage condition. If the engineer finds the following situations, it is suggested purchasing new product:

- The MK350N Premium series product or part is not available anymore;
- The functions of the device can't be recovered due to the damage caused by water, strong collision, serious contamination or corrosion.
- The product is deformed due to falling or strong collision, and the functions can't be recovered even if the main parts are replaced.
- The product is aging or used in adverse environment, so many parts don't work normally. In this case, it has to be changed.
- The part is not available even if it is in the warranty period.



5.2 Measurement Indexes

Abbreviation	Full Name	Unit	Description
CCT	Correlated Color Temperature	K (kelvin)	The color temperature is the color radiated by a black-body radiator under different temperatures. CCT has the color that is the closest to the ideal black-body radiator.
CRi (Ra)	Color Rendering Index	---	As defined by CIE, R1~R8 represent the value of eight standard colors, while CRi(Ra) is the average value of R1~R8. The value 100 indicates the best quality of light source, while the value 0 indicates the worst quality of light source.
R1 - R2 ...R15	Rendering Index	---	It represents the quality of light source, with the indexes corresponding to 15 standard colors, including: R1: light grey-red; R2: dark grey-yellow; R3: saturated yellow-green; R4: middle yellow-green; R5: light

next page



5.2 Measurement Indexes

			yellow-green; R6: light blue; R7: light purple-blue; R8: light red-purple; R9: saturated red; R10: saturated yellow; R11: saturated yellow; R12: saturated yellow; R13: white skin color; R14: Leaf green; and R15: yellow skin color.
LUX	Illuminance	lx	It is the light flux received by each unit area.
λ_p (Lambd aP)	Peak wavelength	nm	It is the wavelength with the highest power in the measured spectrum.
λ_{pV} (Lambd aPV)	Peak wavelength value	mW/m ²	It is the highest power in the measured spectrum, in the unit: mW/m ² .
λ_d (Lambd aD)	Dominant wavelength	nm	The dominant wavelength is used to express the color of the measured light. It could be hybridized by the spectrum color of the wavelength and the standard illuminant E(x, y = 0.333, 0.333).
I-Time	Integration time	ms	The integration time measured by the spectrometric.



5.2 Measurement Indexes

Abbreviation	Full Name	Unit	Description
x y X Y Z	CIE 1931 color coordinate	---	The color coordinate was built by CIE in 1931.
u' v'	CIE 1976 color coordinate	---	The color coordinate was built by CIE in 1976.
Duv (Δu)	CIE 1960 uv color coordinate difference	---	It is the uv distance between CIE 1960 coordinate and the Planck's blackbody radiation with the same color temperature. The value close to 0 indicates the color temperature and color are close to that of the blackbody radiation. The positive value indicates it is above the blackbody radiation, while the negative value indicates it is below the blackbody radiation.
Δx (deltax) (dx)	CIE 1931 x color coordinate difference	---	It is the x difference between CIE 1931 coordinate and the Planck's blackbody radiation with the same color temperature.



5.2 Measurement Indexes

Δy (deltay) (dy)	CIE 1931 y color coordinate difference	---	It is the y difference between CIE 1931 coordinate and the Planck's blackbody radiation with the same color temperature.
$\Delta u'$ (deltau) (du)	CIE 1976 u' color coordinate difference	---	It is the u' difference between CIE 1976 coordinate and the Planck's blackbody radiation with the same color temperature.
$\Delta v'$ (deltav) (dv)	CIE 1976 v' color coordinate difference	---	It is the v' difference between CIE 1976 coordinate and the Planck's blackbody radiation with the same color temperature.
fc	Footcandle	fc	It is based on the unit of lm/ft^2 .
Purity	Color purity	%	It is the percent of the dominant wavelength in the standard illuminant. The closer the color purity is to 100%, the closer it is to the dominant wavelength.
PPFD (PPF)	Photosynthetic Photon Flux Density	$\mu\text{mol}/$ $(\text{sec}\cdot\text{m}^2)$	It is the Photosynthetic Photon Flux Density defined in 400-700nm.



5.2 Measurement Indexes

S/P (SP-ratio)	Scotopic vision/ photopic vision ratio	---	The sensitivity of human eyes varies with the light of different wavelength. It can get the data such as illuminance based on the brightness function. However, the brightness function is different for human eyes under high brightness and low brightness. Therefore, it defines the ratio of photopic vision under high brightness and scotopic vision under low brightness, which is called S/P ratio.
GAI	Gamut Area Index	---	The Gamut Area Index is the ratio between the area of the eight standard colors (R1~R8) on CIE1976 coordinate measured by CRI and the area measured with the standard illuminant E _{xy} = (0.333, 0.333). The higher the value is, the more saturated and bright the color is.



5.2 Measurement Indexes

TLCI	Television Lighting Consistency Index	---	The parameter is defined by referring to European Broadcasting Union (EBU), which is used to evaluate the light source under for television lighting.
W/m ²	Irradiance	W/m ²	It is the irradiance within the range of the wavelength specified in the specification.
BIN	---	---	To classify the chromaticity of LED, ENERGY STAR combines with ANSI C78.377 standard to classify various classes and make uniform BIN types. So the user may distinguish the chromaticity of LED products easily.
SDCM	Standard Deviation Color Matching	---	SDCM has the same meaning with that of Macadam Ellipse. The color within Macadam Ellipse (SDCM=1) drawn on the coordinate can't be identified by human eyes.



5.2 Measurement Indexes

TRANSMIT	Transmittance	%	The transmittance is defined as (the radiant flux transmitted/the radiant flux received) x100 %, based on which the wavelength response can be obtained.
Rf	TM30 Rf	---	It is a rating method proposed by IES for the performance of light source. Different from 8 standard colors, it defines 99 standard colors to present the performance of various wavelengths. Rf represents the similarity between the target light source and the reference light source under the standard color. The value 100 represents it is identical, while the value 0 represents great difference. Rg represents the saturation difference between the target light source and the reference color. The value 100 represents the saturation is the same, while the value larger than 100 represents saturation is higher, and the value smaller than 100 represents saturation is lower. Moreover, it could identify the difference more obviously through the color vector diagram and the color tolerance diagram.
Rg	TM30 Rg		



5.2 Measurement Indexes

Index (Flicker Idx)	Flicker index	---	Flicker index = Area above the mean value / Area below the mean value. Higher value represents obvious flicker.
Fpercent (Flicker Pct)	Flicker percent	%	Flicker percent = (Maximum value - minimum value) / (Maximum value + minimum value). Higher value represents obvious flicker.
SVM	Stroboscopic Effect visibility Measure	---	SVM is an index used to quantify the flicker effect. Higher value represents obvious flicker effect.
Freq (Frequency)	Flicker Frequency	Hz	It is the flicker rate of the measured light, or the frequency shown per second.
Twave	Flicker Cycle	ms	It is the countdown of the flicker frequency of the measured light, or the time of one flicker.
Mired	Mired	MK ⁻¹	Mired = 100 000 / CCT, is the deviation unit of the color temperature of the filter.



The following situations are not fault. Please double check it before requesting for repair. If it doesn't work normally after the inspection, it could be caused by fault of the device. In this case, please take out the battery and contact the seller or the vendor for repair.

State	Inspection item	Solution
Power-on failure (No display)	Check whether the battery is installed correctly.	Please don't install the battery inversely, or push it in violently, which may destroy the battery spring.
	Check whether the battery runs out of power.	Please charge the battery for 6 hours for the first use. (Please refer to 2.1.)
	Check whether the battery connector is dirty	Please wipe it with dry cloth.

Item	Solution
Why I feel the card is stuck when inserting and unplugging it?	It is the anti-sneaking function designed specially. It prevents SD card shedding in case of collision under external force, which may cause write-in error.
What is the function of dark calibration? Do I need to perform dark calibration at every startup.	The dark calibration is also known as dark calibration. As the temperature change of the environment affects the measurement, the user is suggested to perform dark calibration before measurement, so as to improve the measurement accuracy. (As for the calibration instruction, please refer to 2.6.)
Why my SD card can't be used on MK3SDN Premium?	The SD card should be formatted into FAT before being inserted into MK3SDN Premium. Moreover, the memory of SD card is required to be 32G or higher.



To get more information related to operation, firmware upgrade and warranty terms, define application for consultation and repair service, please visit www.upatek.com to download the complete version.